

# SPRINKLER LAYOUT FOR PENDENTS & UPRIGHTS: PEAKED ROOFS

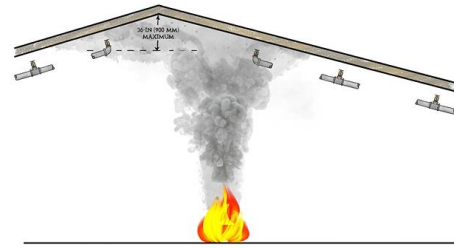

M

M

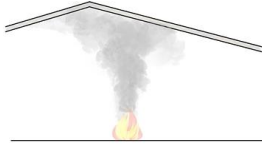
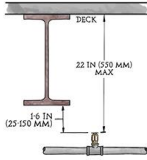
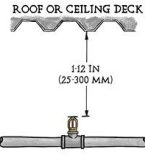
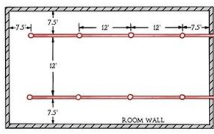
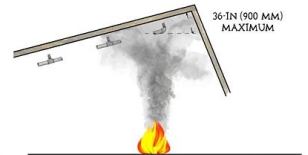
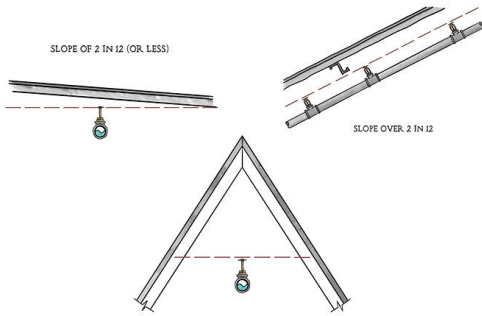

M

M

## NOTES

Grid of dots for notes.

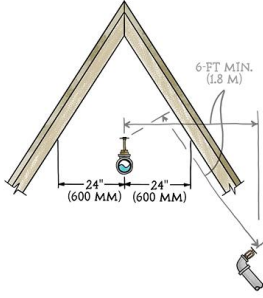

M



M

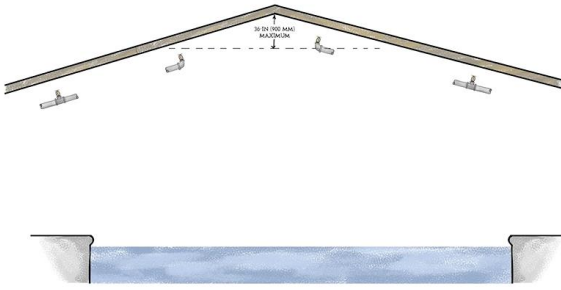

M

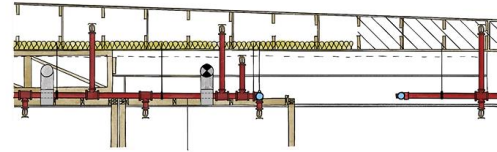

M

NOTES

Grid of dots for notes.

## SPRINKLER LAYOUT FOR PENDENTS & UPRIGHTS: PEAKED ROOFS

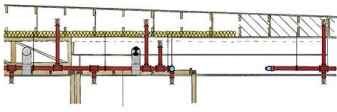

### PEAKED ROOFS/CEILINGS:

- TOP-MOST SPRINKLER WITHIN 36-INCHES (900 MM) OF PEAK
- EXCEPTION FOR SAW-TOOTH ROOFS
- EXCEPTION FOR STEEP SLOPES



### NOTES

A large area of the page is filled with a grid of small dots, intended for handwritten notes.