

# COMPONENTS OF PRE-ENGINEERED METAL BUILDINGS?

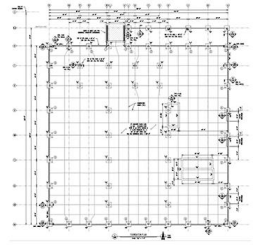

M

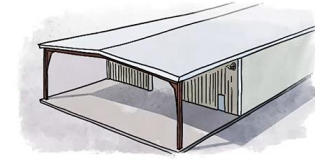
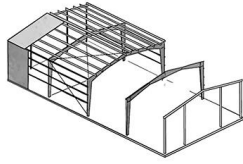

M

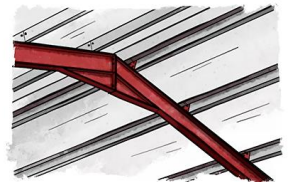
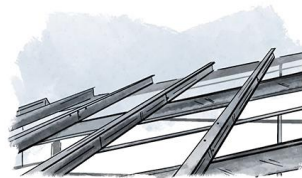

M

M

## NOTES

A large area of dotted lines for taking notes.

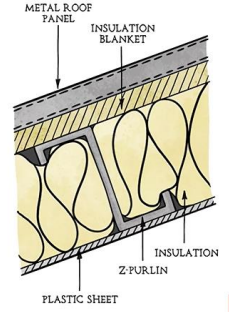
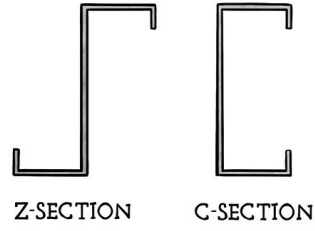
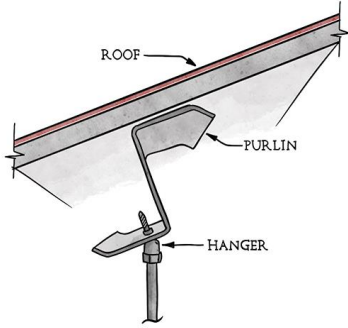

M

M

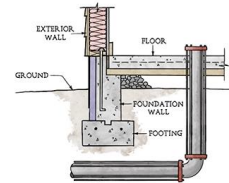
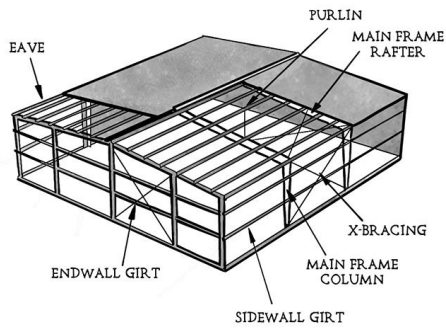

M

M

NOTES

Grid area for notes.