

HOW DO BEAMS AFFECTS SPRINKLERS AND DETECTORS?

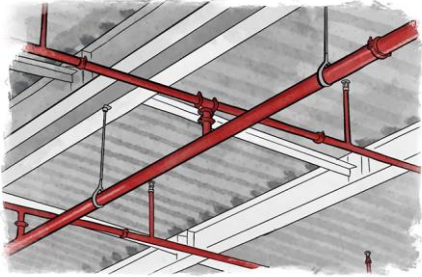

M

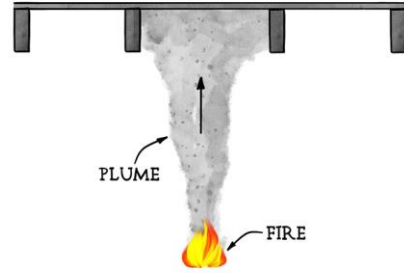

M

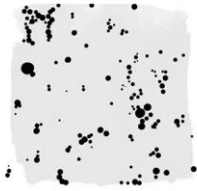

M

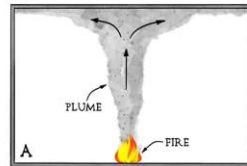

A

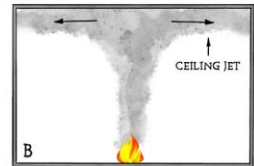

B



C

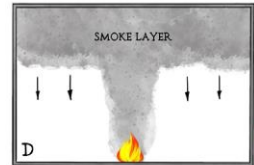

D

M

NOTES

Grid of dotted lines for taking notes.

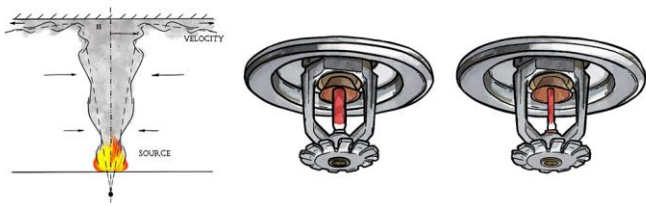

M

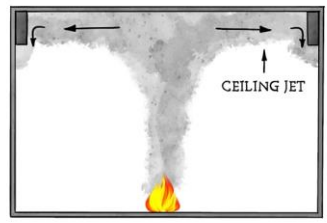

M

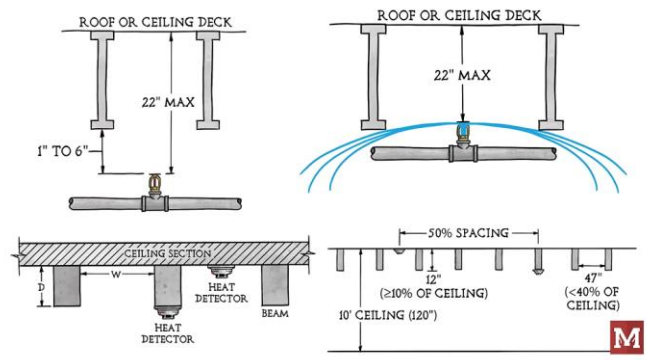

M

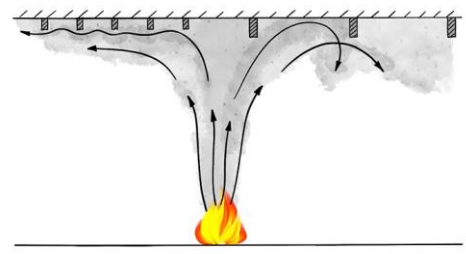

M

NOTES

A large area of dotted lines for taking notes.